

Series L Adjustable Height Desk



Series L Adjustable Height Double Desk



SERIES L ADJUSTABLE HEIGHT DESK

The Series L Adjustable Height Desk is the 3-stage Sit/Stand solution for the modern workspace. Designed for optimal ergonomic performance and maximum accessibility, it provides the flexibility to transition from sitting to standing in seconds.

4 Formats for the Way You Work



SINGLE DESK

DOUBLE DESK

CORNER DESK

120° DESK

Bells + Whistles

- Position the Series L's work surface at any height between 25" and 50.5" to get your keyboard at the optimal ergonomic level
- The extended range of motion supports multiple uses, from low table to standing desk for someone up to 6'6"
- Electrically-driven legs move surface up or down with the touch of a button
- Four memory buttons for programming your preferred heights
- Laminate tops are stain-resistant and easy-to-clean
- Resilient soft edge desktop band protects desk from dings
- Plugs into a standard 15A outlet
- Tool assembly required; White Glove installation recommended
- Customize with 8 different top finishes and sizes to get the right look for your office
- The Series L Desk System has achieved Indoor Advantage Gold Certification
- Meets the durability standards for the commercial office industry (BIFMA)
- If BIFMA's ergonomic G1 standards and ADA compliance are of value to your team, the Series L may fulfill your needs—reach out to your Account Executive to learn more
- Designed by Poppin in NYC



Handset shown: Series L Single Desk, Series L 120° Desk

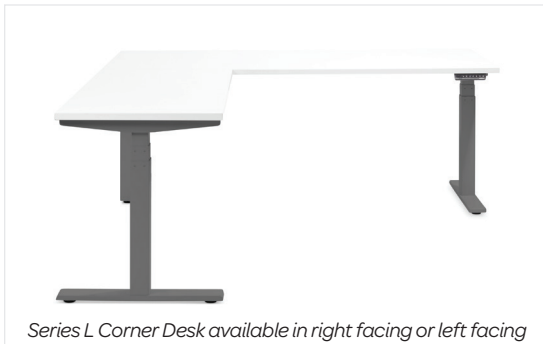

Series L Corner Desk available in right facing or left facing



Handset shown: Series L Double Desk, Series L Corner Desk

Features four memory buttons for programming your preferred heights



Series L 120° desks allow for more private space



Contact Us

(888) 676-7746 sales@poppin.com poppin.com/showrooms



Series L Adjustable Height Double Desk for 4

DOUBLE DESK BENCHING

Series L Double Desk Couplers are included with all Double Desks for 4 or more. Designed to join desks together side by side, it keeps everyone in line and evenly spaced.

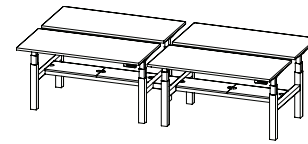

DOUBLE DESK FOR 4

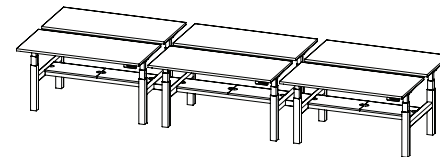

DOUBLE DESK FOR 6

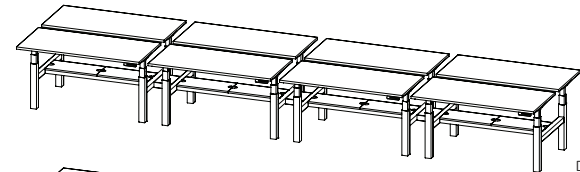

DOUBLE DESK FOR 8

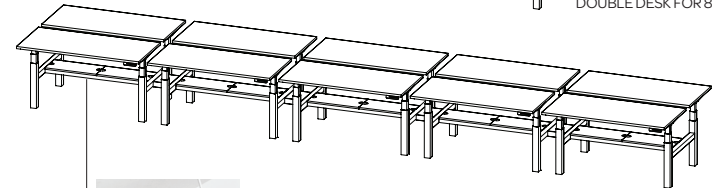

DOUBLE DESK FOR 10



INTEGRATED POWER TRAY

Featuring a built-in power tray that carries electrical power down the length of the desk. Two covers help conceal excess cables with multiple cutouts on top and bottom to route cables through.

Contact Us

(888) 676-7746 sales@poppin.com poppin.com/showrooms

120° DESK BENCHING

Provide extra personal space and move your team's benching away from the wall with our 120° desks.



Contact Us

(888) 676-7746

sales@poppin.com

poppin.com/showrooms

PRIVACY + POWER

From integrated power systems to cable management solutions, our Series L accessories let you customize your standing desk to meet all the needs of busy teams.

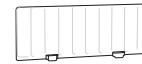

1. PRIVACY + MODESTY PANELS

Find more personal space in the open office with our pinnable or translucent Privacy and Modesty Panels.



2. POWER POINTS OUTLET

Add outlets at your fingertips for full power and USB charging whenever you need it. Clamp it to the desk edge and plug into the 4-Trac Electrical System (sold separately) installed in the Power Tray.



3. SERIES L CABLE HIDEAWAY

Designed to fit under our Series L Desk Top, the Cable Hideaway is an elegant way to reduce visual clutter and hide all your loose cables. Mounting screws included.

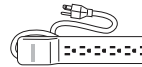

4. POWER STRIP

A power strip minimizes the number of power cords extending from the desk surface into the Power Tray, ensuring less mess and risk of entanglement as the desk moves. Mounting screws included.



5. BYRNE 4-TRAC POWER

The Byrne 4-Trac Electrical System is an economical, streamlined power distribution solution that is easy to install and adapt based on your needs. The system is available with a plug end that goes directly into a 20 amp wall outlet, or it can be hard-wired into your building's electrical grid.



CABLE MANAGEMENT COLUMN *not shown*

Our Cable Management Column is designed to channel multiple cables to create a clean look and minimize cord clutter. The column works best with Series L Single Desks and the Series L Corner Desk.

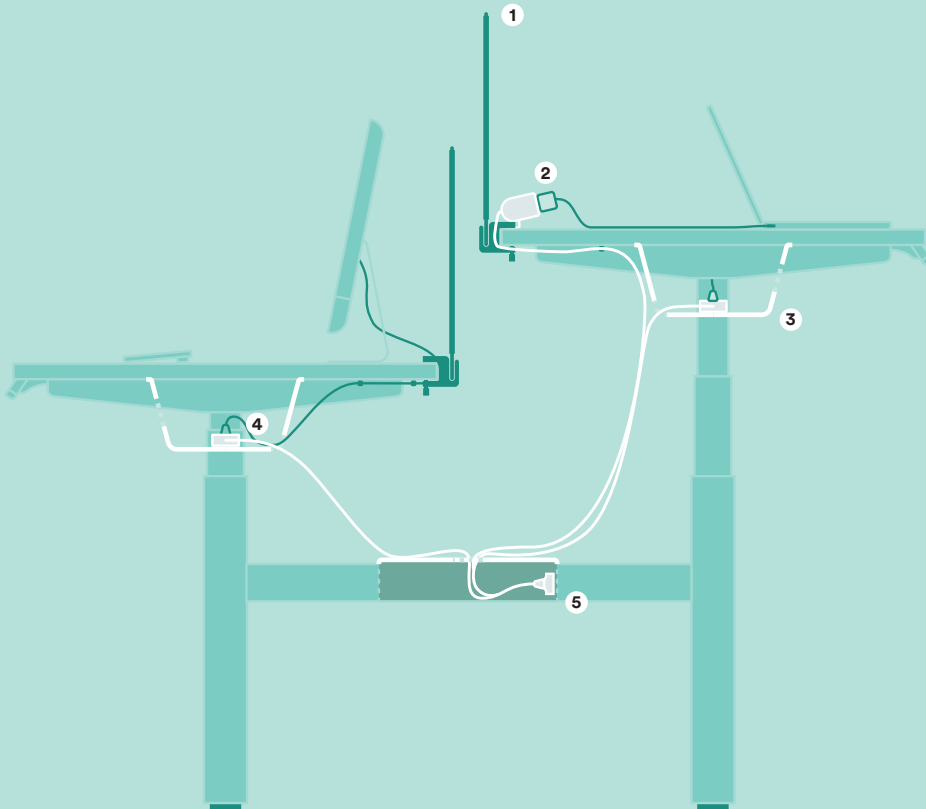

Contact Us

(888) 676-7746 sales@poppin.com poppin.com/showrooms

CUSTOM ORDER TOPS

Customize your Series L Adjustable Height Desk with a variety of laminate desktops from the Kimball International library so you can coordinate with any office aesthetic.



Almond



Portico



Natural (NM)



Monteray (YO)



Sable

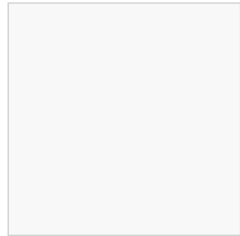

Designer White







Willow (WL)

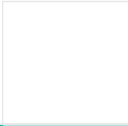
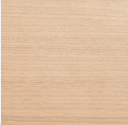
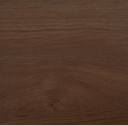
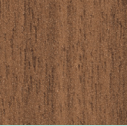

COLOR + SIZE OPTIONS

Call us with questions or to request swatches.

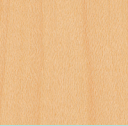
(888) 676-7746 sales@poppin.com

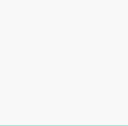
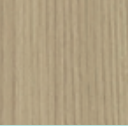
											
TABLETOP SIZE (WIDTH, DEPTH)		WHITE	NATURAL OAK	WALNUT	ALMOND	PORTICO	NATURAL (NM)	MONTERAY (YO)	SABLE	DESIGNER WHITE	WILLOW (WL)
47"	27"	●	●	●	●	●	●	●	●	●	●
	30"	●	-	-	●	●	●	●	●	●	●
54"	27"	●	-	-	●	●	●	●	●	●	●
	30"	●	-	-	●	●	●	●	●	●	●
57"	27"	●	●	●	●	●	●	●	●	●	●
	30"	●	-	-	●	●	●	●	●	●	●
60"	27"	●	-	-	●	●	●	●	●	●	●
	30"	●	●	●	●	●	●	●	●	●	●
66"	27"	●	-	-	●	●	●	●	●	●	●
	30"	●	-	-	●	●	●	●	●	●	●
72"	27"	●	-	-	●	●	●	●	●	●	●
	30"	●	●	●	●	●	●	●	●	●	●
CORNER DESK											
72" x 77"		●	-	-	●	●	●	●	●	●	●
120° DESK											
79" x 44.5"		●	-	-	-	-	-	-	-	-	-

KEY // ● In Stock ● Special Order Only: 4-6 Weeks, Minimum order of 12

DIMENSIONS BY FORMAT

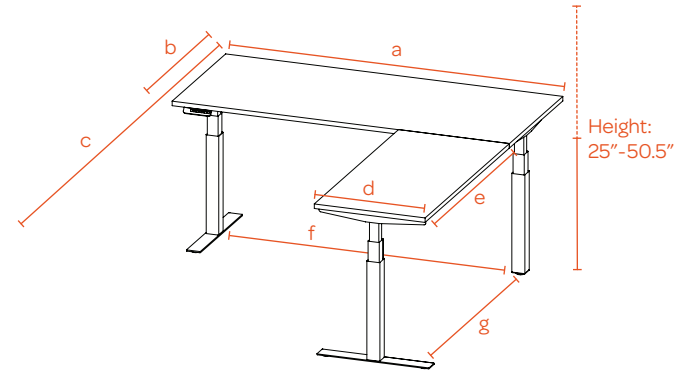
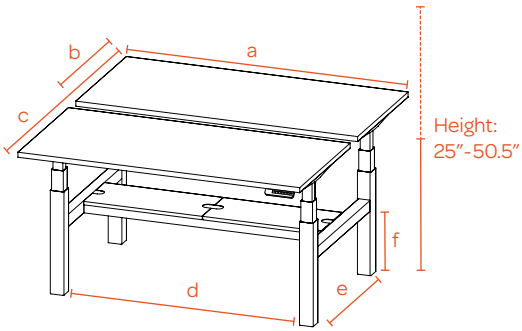
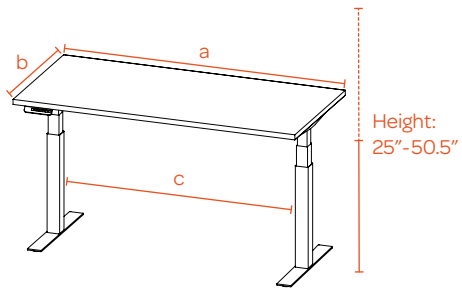

Series L Single Desk

A	B	C
47.25"	27"	37.75"
	30"	37.75"
54"	27"	43.75"
	-	-
57"	27"	47.75"
	30"	47.75"
60"	27"	50.75"
	30"	50.75"
66"	27"	56.75"
	-	-
72"	27"	62.75"
	30"	62.75"

Series L Double Desk

A	B	C	D	E	F
47.25"	27"	58"	37.75"	28.25"	13.5"
	30"	64"	37.75"	28.25"	13.5"
54"	27"	58"	43.75"	28.25"	13.5"
	-	-	-	-	-
57"	27"	58"	47.75"	28.25"	13.5"
	30"	64"	47.75"	28.25"	13.5"
60"	27"	58"	50.75"	28.25"	13.5"
	30"	64"	50.75"	28.25"	13.5"
66"	27"	58"	56.75"	28.25"	13.5"
	-	-	-	-	-
72"	27"	58"	62.75"	28.25"	13.5"
	30"	64"	62.75"	28.25"	13.5"

For benching, add 4" between each Double Desk where coupler is installed.

Series L Corner Desk

A	B	C	D	E	F	G
72"	30"	77"	23.5"	47"	61"	56"

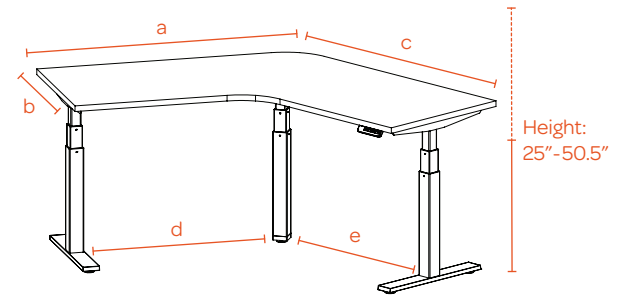

Series L 120° Desk

A	B	C	D	E
50"	27"	50"	36"	36"