

Raise Adjustable Height Desk

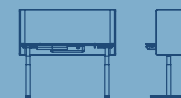



Pinnable Privacy Shields for Raise coming Fall 2020 (sold separately)

RAISE ADJUSTABLE HEIGHT DESK

Assemble our Raise Adjustable Height Desk completely without tools— all in under 2 minutes per desk! Our patent pending lever eliminates screws and tools, giving you the option to quickly build, reconfigure, or move your Sit/Stand desk anywhere in the office with ease. Designed for ideal ergonomic work, the Raise allows you to transition from sitting to standing in seconds, giving you total flexibility throughout your work day.

Bells + Whistles

- The Raise’s patent pending lever eliminates screws and tools, allowing anyone to put the desk together in under 2 minutes, saving you time and assembly expenses
- Position the Raise’s work surface at any height between 25” and 50.5” to get your keyboard at the optimal ergonomic level
- The extended range of motion supports multiple uses, from low table to standing desk for someone up to 6’6”
- With electric legs traveling at 1.4” per second at a noise level below 50dB, you can quickly and quietly move from sitting to standing
- Intuitive LED lever handset moves your desk with natural up/down hand motions
- Desk bases can support and lift up to 300 pounds
- Simply plug the desk base into a standard 15A outlet
- Leave your latte: the laminate tops are stain-resistant and easy to clean
- Meets or exceeds BIFMA’s durability standards for office furniture
- Casters sold separately
- Designed by Poppin in NYC



Simple, patent pending tool-free assembly

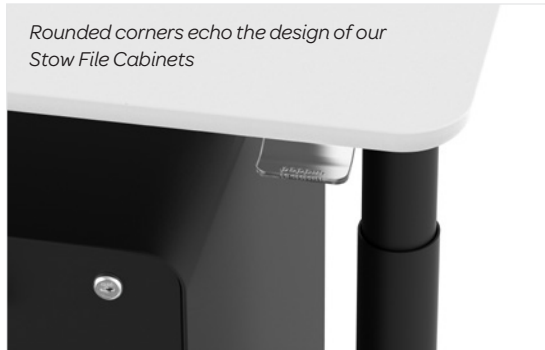

Rounded corners echo the design of our Stow File Cabinets



Optional casters available

Contact Us

888-676-7746 poppin.com/contact poppin.com/showrooms

PRIVACY + POWER

Customize any Poppin desk to meet the needs of busy teams with our accessories. From integrated power systems to cable management solutions, use these compatible add-ons that work great with Raise.

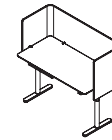

1. PINNABLE PRIVACY SHIELD

Find more personal space in the open office with our Pinnable Privacy Panel (shown here) or our Translucent Privacy Panels.

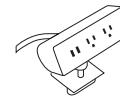

2. POWER POINTS OUTLET

Add outlets at your fingertips for full power and USB charging whenever you need it.

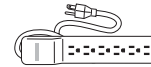

3. POWER STRIP

A power strip minimizes the number of power cords extending from the desk surface into the Power Tray, ensuring less mess and risk of entanglement as the desk moves. Mounting screws included.



4. CABLE HIDEAWAY

Designed to fit under your desk, the Cable Hideaway is an elegant way to reduce visual clutter and hide all your loose cables. Mounting screws included.



5. CABLE MANAGEMENT COLUMN

Our Cable Management Column is designed to channel multiple cables to create a clean look and minimize cord clutter.

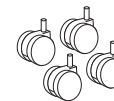

6. CASTERS, SET OF 4

Add on our set of optional casters—two locking and two non-locking for safety—to give your Raise desk the option to roll.

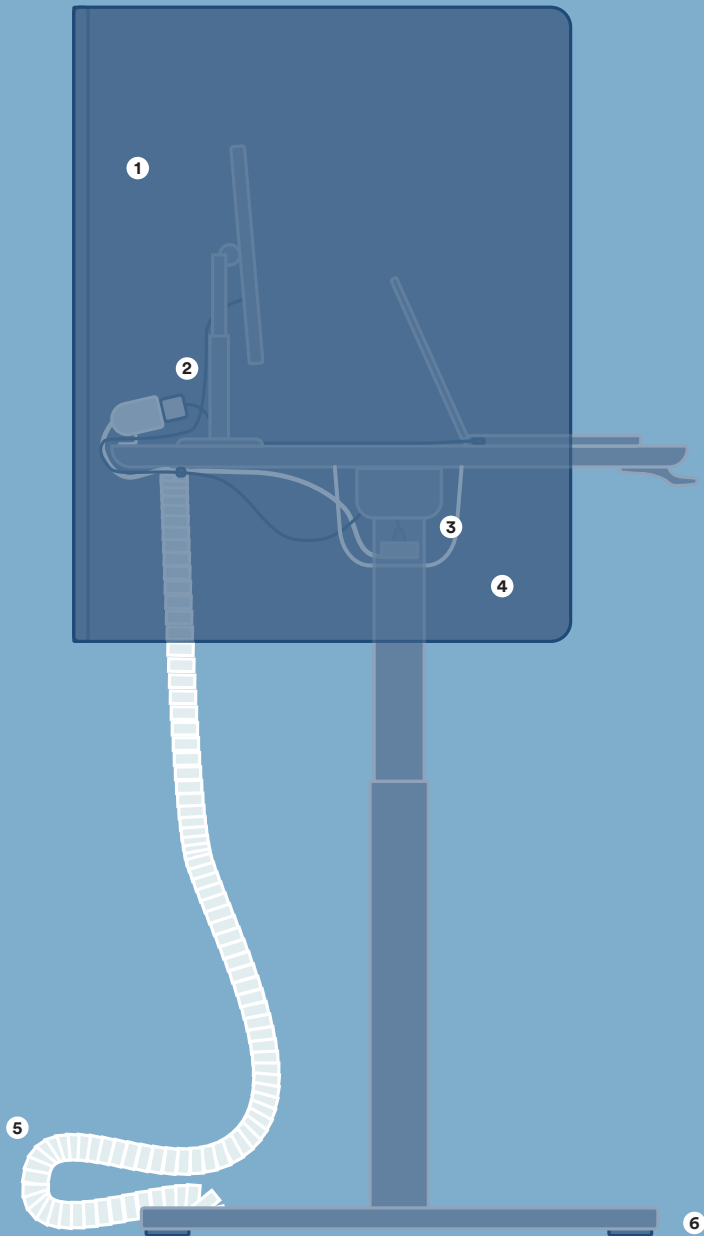

Contact Us

888-676-7746 poppin.com/contact poppin.com/showrooms

DESIGNED FOR FLEXIBILITY

Alternate Sides

Help employees keep 6' of distance while staying connected with their team in a traditional "pod" layout.

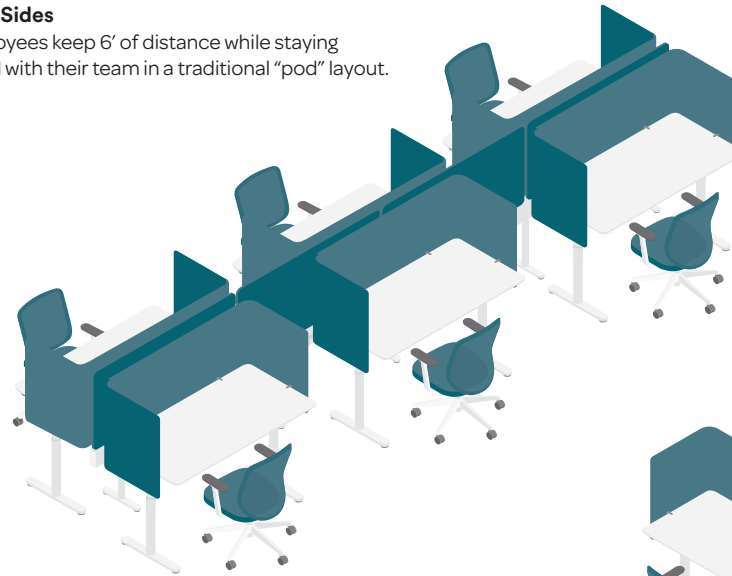
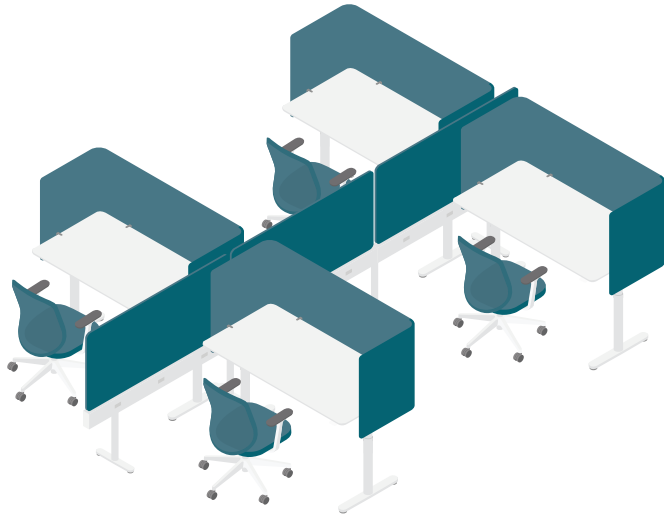

Side-to-Side

Use the Boom Power Rail and Privacy Panels to free-float a pod of desks away from walls and in the middle of an office space.

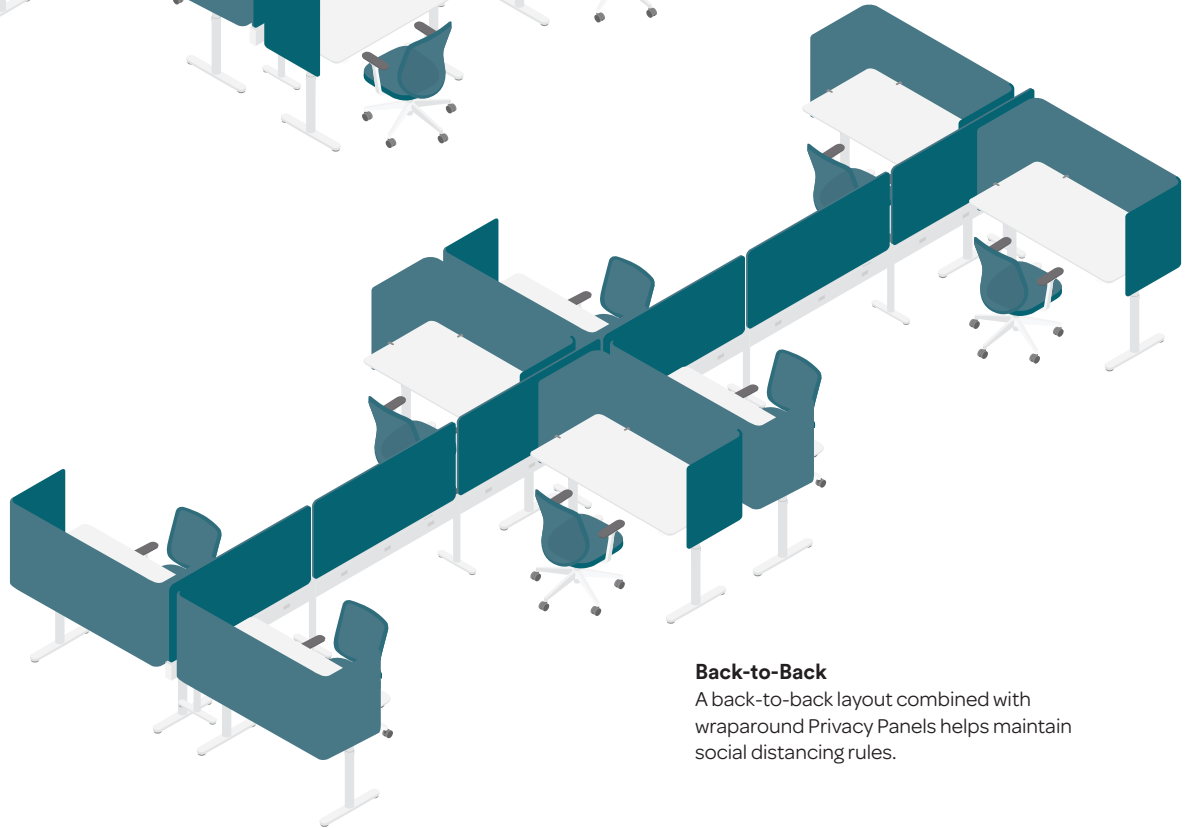

Back-to-Back

A back-to-back layout combined with wraparound Privacy Panels helps maintain social distancing rules.

Contact Us

888-676-7746 poppin.com/contact poppin.com/showrooms

COLOR + SIZE OPTIONS

Call us with questions or to request swatches.

(888) 676-7746 sales@poppin.com

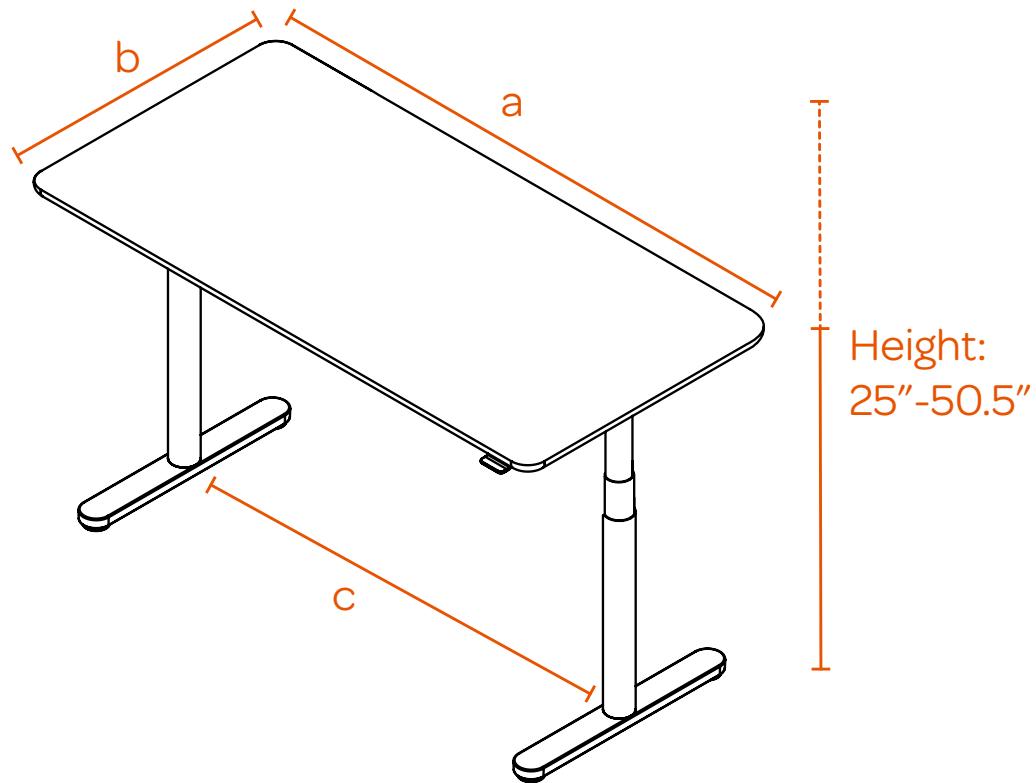

Raise Single Desk

A	B	C
48"	30"	37"
60"	30"	49"

TABLETOP SIZE (WIDTH, DEPTH)			
	WHITE	NATURAL OAK	WALNUT
48" 30"	●	●	●
60" 30"		●	●
LEG COLOR			
White	●	●	●
Black	●	●	●

Contact Us

888-676-7746 poppin.com/contact poppin.com/showrooms