

the quiet time

QT Lounge High or Low Sofas

ASSEMBLY INSTRUCTIONS

Included in the boxes:

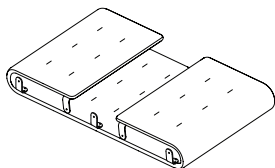

SURROUND

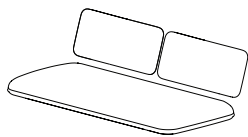

SEAT + BACK PILLOWS



ALLEN WRENCH



LEGS



SCREW

ASSEMBLY

1. Align the seat and surround as shown below.
2. Screw in the legs following the numbered sequence.

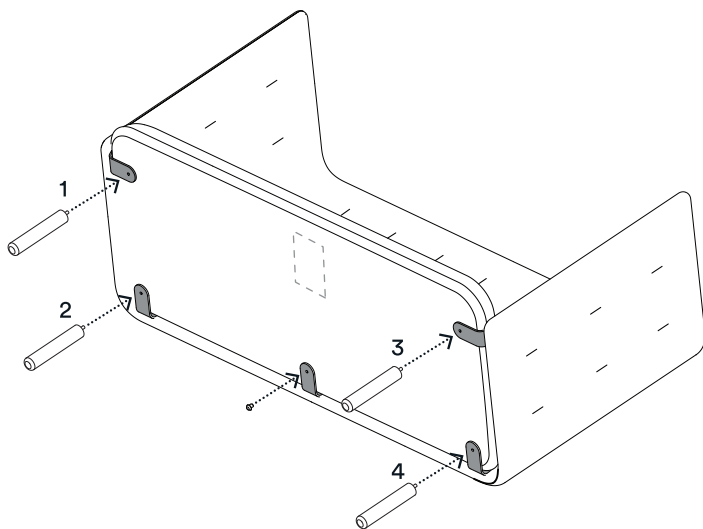

3. Use the allen wrench to install the screw.
4. Stand upright and drop in the back pillows.

QT LOUNGE HIGH SOFA

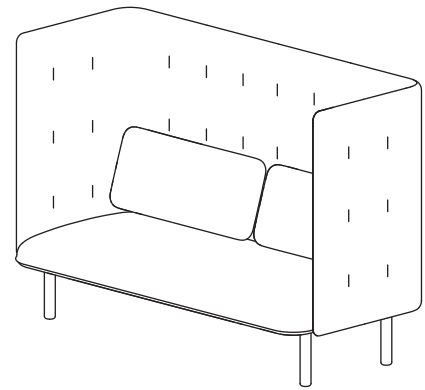

QT LOUNGE LOW SOFA

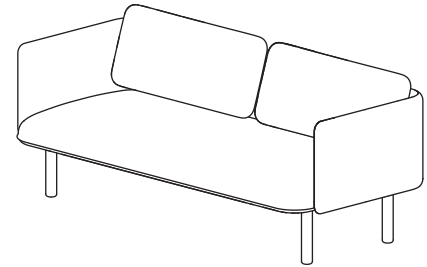

ABOUT POPPIN

We're the easiest way to outfit your office. From our award-winning design to our helpful team of experts, we've built our brand to radically simplify the office furniture industry.

CARE

We recommend annual professional upholstery cleaning for maximum long-term performance and best appearance. Spot-clean using an upholstery cleanser formulated for Polyester fabrics.

100% WORK HAPPINESS GUARANTEE

For full warranty details, visit poppin.com

WARNING/DISCLAIMER

Listen up, daredevils! (And anyone trying to reach that top shelf). Do not stand on this product. Use only as intended. Failure to follow these instructions could result in property damage or personal injury.

Shop the complete furniture collection at poppin.com



Designed by Poppin in NYC

Poppin, Inc.
1115 Broadway, 3rd Floor
New York, NY 10010

(888) 676-7746
hi@poppin.com
[@workhappy @poppin](https://www.instagram.com/workhappy)

For patent or patent application
information visit poppin.com/patents
©Poppin 2018

v01_Dec2018

the quiet time

QT Lounge Privacy Panel

ASSEMBLY INSTRUCTIONS FOR QT SOFA AND CHAIR BOOTHS

Included in the boxes:

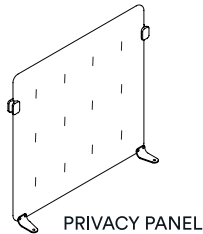

ASSEMBLY

1. Complete the assembly of your QT Lounge Sofas or Chairs.
2. Using the screws and allen wrench provided with the sofa, connect one side of the privacy panel to one side of the sofa or chair.

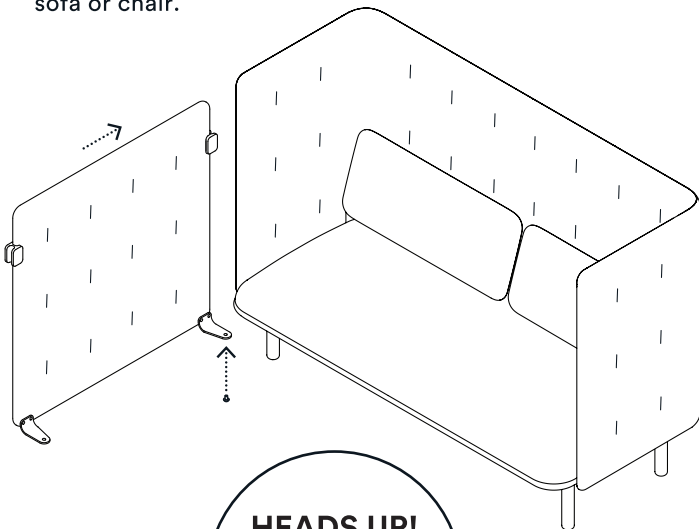

HEADS UP!

Panels can be connected to either side of the QT sofas and chair base.

3. Align the second sofa or chair with the panel and install the second screw provided with the panel.

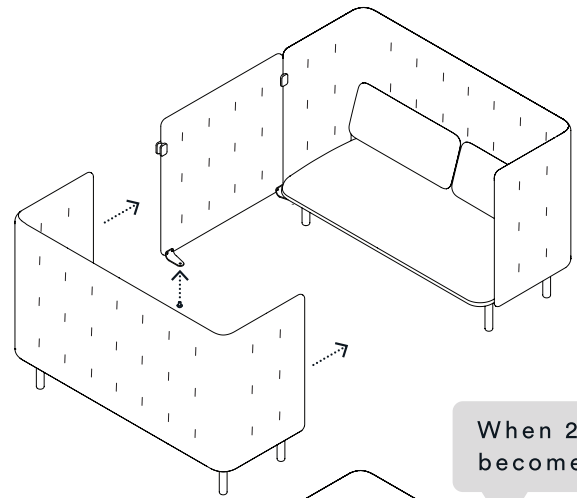

When 2
become 1.

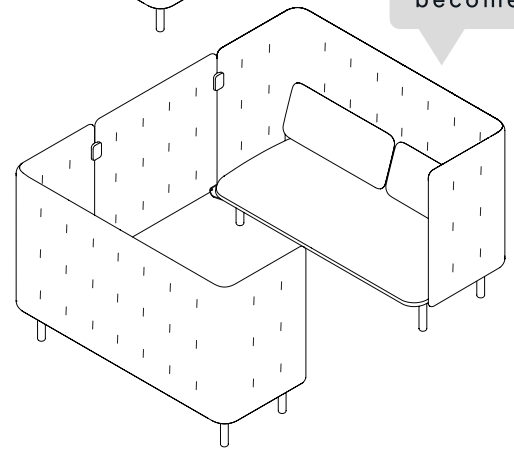

ABOUT POPPIN

Poppin's furniture and office supplies are designed with your success in mind. From a day-brightening Stapler to a game-changing Desk System, Poppin is the one-stop shop for creating inspiring, modern workspaces.

CARE

Doing a little dirty work? Soak up the spill and then blot with warm water + mild soap.

100% WORK HAPPINESS GUARANTEE

For full warranty details, visit poppin.com

WARNING/DISCLAIMER

Listen up, daredevils! (And anyone trying to reach that top shelf). Do not stand on this product. Use only as intended. Failure to follow these instructions could result in property damage or personal injury.

Designed by Poppin in NYC

Shop the complete furniture collection at poppin.com

Poppin, Inc.
1115 Broadway, 3rd Floor
New York, NY 10010

(888) 676-7746
hi@poppin.com
[@workhappy @poppin](https://www.instagram.com/workhappy)

For patent or patent application
information visit poppin.com/patents
©Poppin 2018

v01_Dec2018